

Bellows suction cups VFX series 30



Suction cups made of G-FLEX material based on polyurethane which have the characteristic of having two different hardnesses:

- Lip softer to 30 shore, and then with a great prehensility even on products relatively difficult because of their porosity, such as.
- Paper and cardboard and bellows 60 shore conferring durability and responsive speed to the suction cup.

As regards available fittings, there is the possibility to integrate a filter made of stainless steel and the check-valve to control vacuum flow.

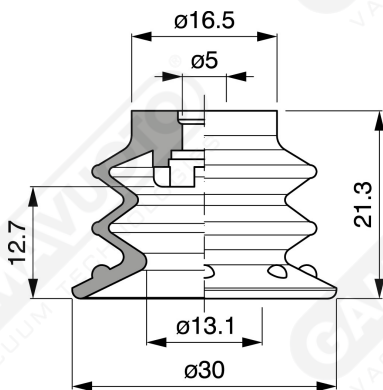

Art. VFX 30 35

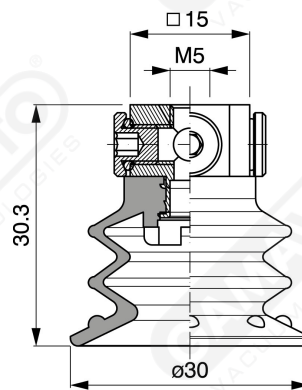

Art. VFX 30 00

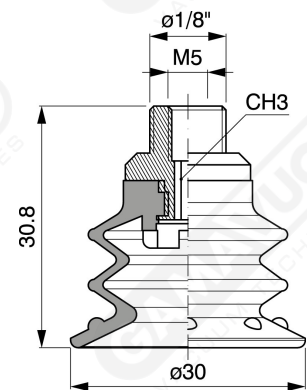

Art. VFX 30 20

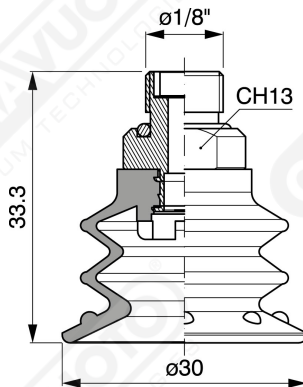

Art. VFX 30 60 ÷ 64

Art. VFX 25 60

with filter

Art. VFX 25 61

with filter and check valve

Art. VFX 25 63

without filter

Art. VFX 25 64

with check valve without filter

F-LINE suction cups VFX series

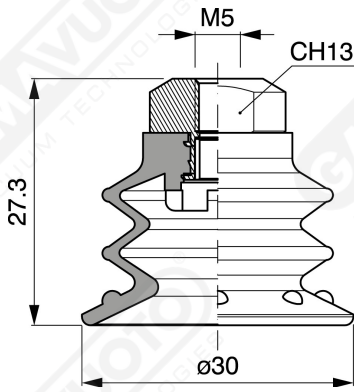

Art. VFX 25 90

with filter

Art. VFX 25 91

with check valve

Art. VFX 25 93

without filter

Art. VFX 30 90 ÷ 93