

Bellows suction cups VES 41 series



VES series suction cups are designed to be the best solution for the handling of plastic bags and other materials.

They consist of two separate parts assembled together. The soft silicone lip guarantees an excellent grip on the deformable surfaces, while the body, with bellows of higher hardness, guarantees excellent resistance to stress.

In the available supports, there is the possibility to integrate a stainless steel mesh filter and the self-pressure valve for vacuum flow control.

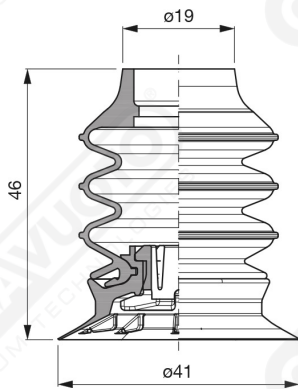

Art. VES 41 35

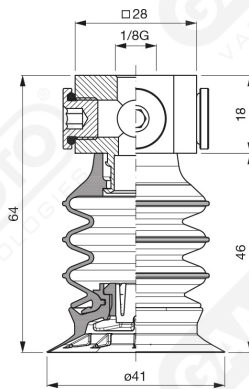

Art. VES 41 00

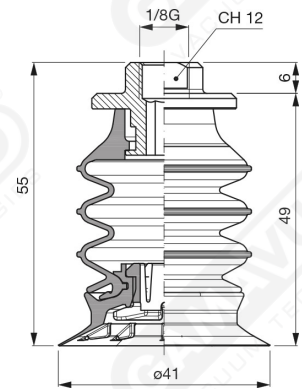

Art. VES 41 20

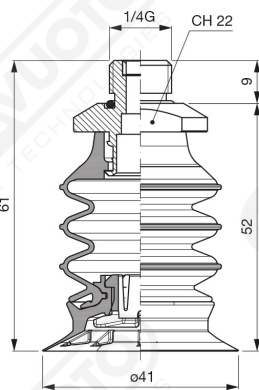

Art. VES 41 70 ÷ 73

Art. VES 41 70
with filter

Art. VES 41 73
without filter

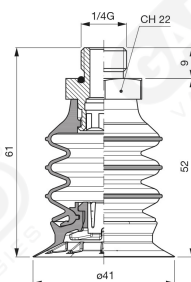

Art. VES 41 74

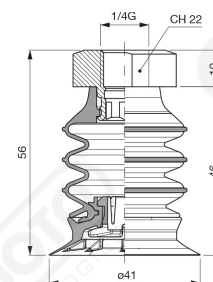

Art. VES 41 76

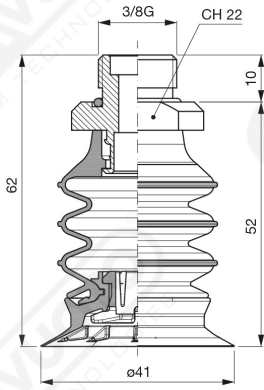

Art. VES 41 80
with filter

Art. VES 41 83
without filter

Art. VES 41 80 ÷ 83

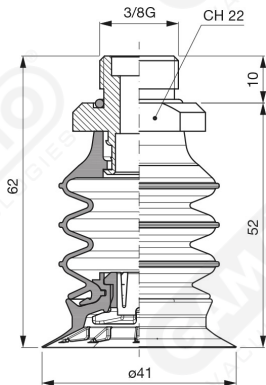

Art. VES 41 84

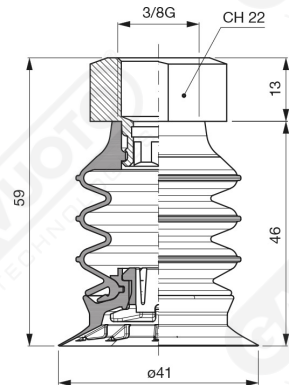

Art. VES 41 86

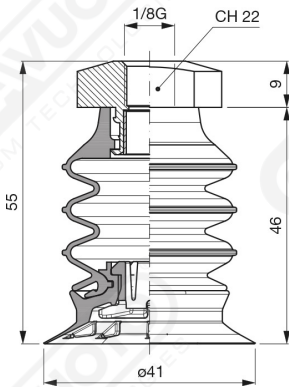

Art. VES 41 90
with filter

Art. VES 41 93
without filter

Art. VES 41 90 ÷ 93

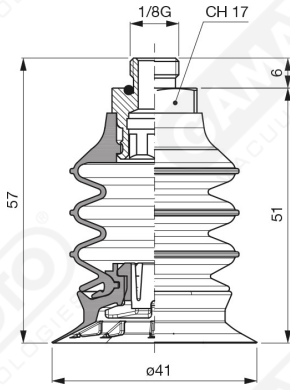

Art. VES 41 94

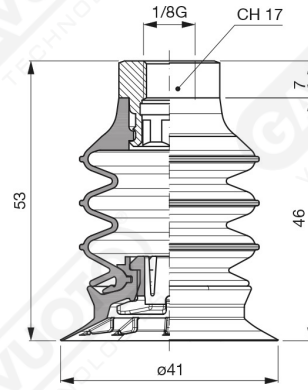

Art. VES 41 96